

Powered by



# CB3.2-12 ▶ 12V3.2Ah

CB3.2-12 is a general purpose battery up to 5 years in standby service or more than 260 cycles at 100% discharge in cycle service. As with all HENGLI batteries, all are rechargeable, highly efficient, leak proof and maintenance free.



## ► Specification

Cells Per Unit	6
Voltage Per Unit	12
Capacity	3.2Ah @ 20hr-rate to 1.75V per cell @25°C (77°F)
Weight	Approx. 1.25 kg(2.75 lbs)
Maximum Discharge Current	48A(5sec)
Internal Resistance	Approx. 50 mΩ
Operating Temperature Range	Discharge: -15°C~50°C ( 5°F~122°F) Charge: -15°C~40°C ( 5°F~104°F) Storage: -15°C~40°C ( 5°F~104°F)
Nominal Operating Temperature Range	25°C±3°C (77°F±5°F)
Float Charging Voltage	13.5 to 13.8 VDC/unit Average at 25°C (77°F)
Recommended Maximum Charging Current Limit	0.96A
Equalization and Cycle Service	14.4 to 15.0 VDC/unit Average at 25°C (77°F)
Self Discharge	HENGLI Batteries can be stored for more than 6 months at 25°C (77°F). Please charge batteries before using. For higher temperatures the time interval will be shorter.
Terminal	F1-Faston Tab187
Container Material	ABS(UL 94-HB) & Flammability resistance of (UL 94-V0) can be available upon request.



IT1720HL22031803

VRLA batteries  
are certified by ISO 9001,  
ISO14001 and OHSAS18001.

## ► Dimensions :

Unit: mm	Overall Height (H)	Container height (h)	Length (L)	Width (W)
	66.5±1.5	61.5±1.5	134±1.5	67±1

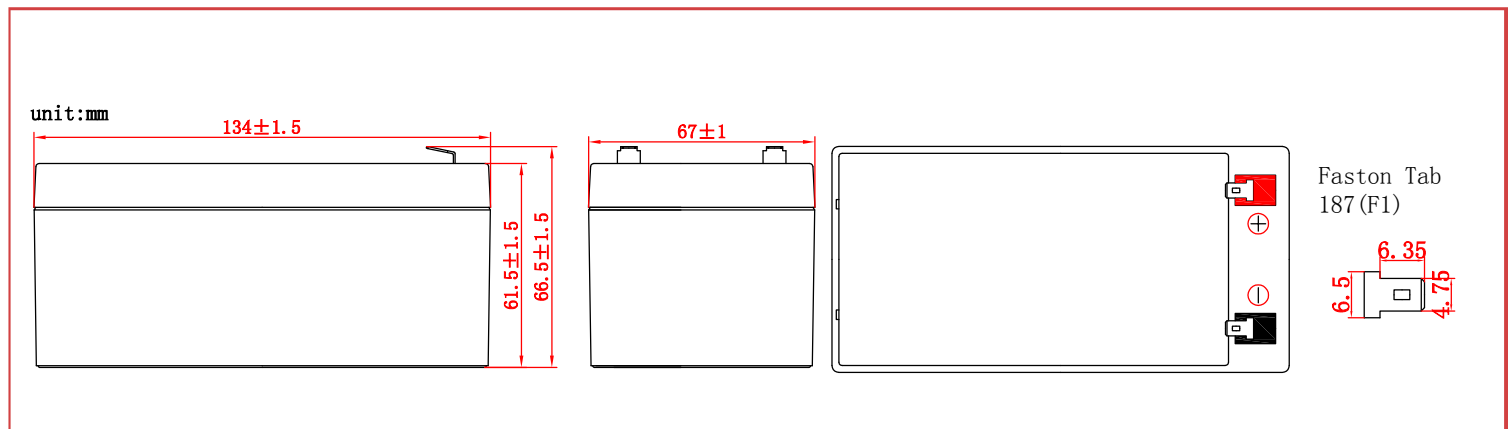

## Constant Current Discharge Characteristics Unit:A (25°C, 77°F)

F.V/Time	5min	15min	30min	1h	3h	5h	10h	20h
1.60V	10.31	5.88	3.38	1.87	0.788	0.538	0.303	0.162
1.67V	10.11	5.73	3.35	1.85	0.782	0.533	0.302	0.162
1.7V	9.97	5.63	3.33	1.83	0.778	0.530	0.301	0.161
1.75V	9.49	5.38	3.26	1.79	0.765	0.522	0.298	0.160
1.8V	8.53	4.96	3.13	1.70	0.737	0.506	0.291	0.157
1.85V	6.62	4.19	2.89	1.56	0.672	0.471	0.275	0.150

## Constant Power Discharge Characteristics Unit:W (25°C, 77°F)

F.V/Time	5min	15min	30min	1h	3h	5h	10h	20h
1.60V	17.66	11.25	6.53	3.55	1.554	1.049	0.596	0.322
1.67V	16.87	10.71	6.48	3.52	1.540	1.045	0.593	0.321
1.7V	16.31	10.34	6.45	3.50	1.532	1.041	0.591	0.320
1.75V	14.92	9.56	6.33	3.44	1.506	1.024	0.584	0.318
1.8V	12.85	8.51	6.09	3.33	1.451	0.990	0.572	0.312
1.85V	10.01	7.15	5.62	3.09	1.338	0.937	0.544	0.300

Ratings presented herein are subject to revision without notice. Please refer to [www.baacebattery.com](http://www.baacebattery.com) and [www.hengli.cn](http://www.hengli.cn) to confirm the latest version.

### Trickle(or Float)Design Life

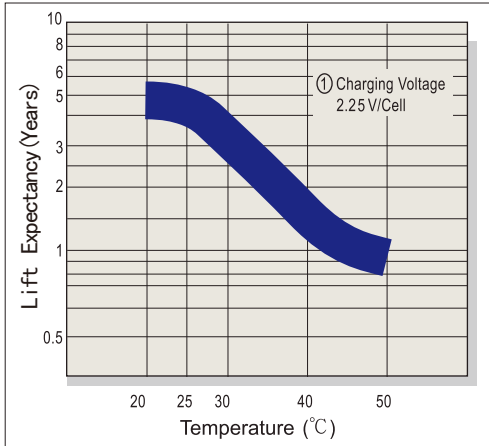

### Capacity Retention Characteristic

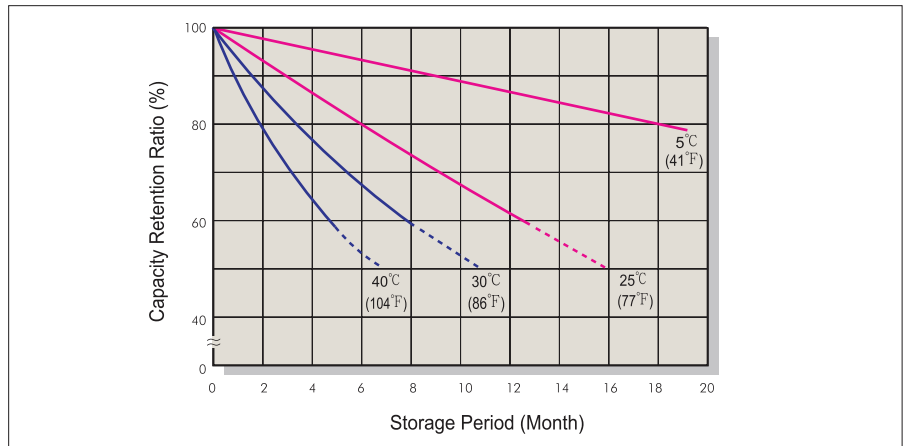

### Battery Voltage and Charge Time for Standby Use

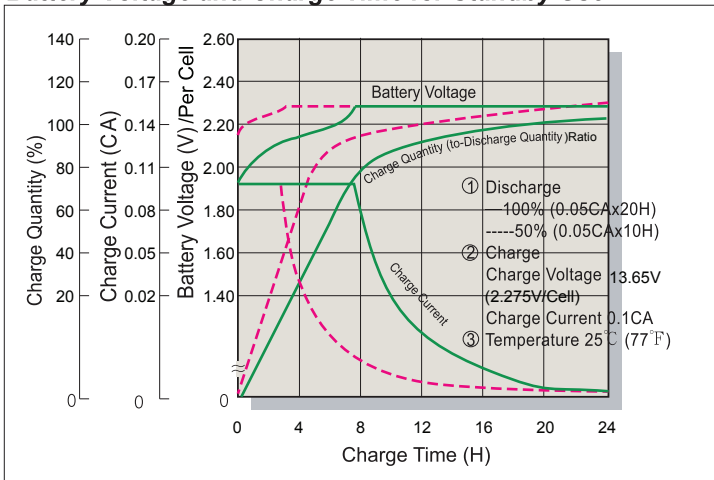

### Cycle Service Life

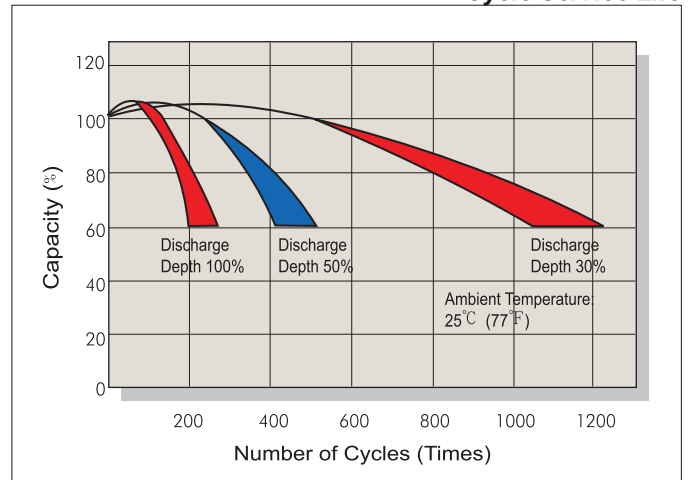

### Battery Voltage and Charge Time for Cycle Use

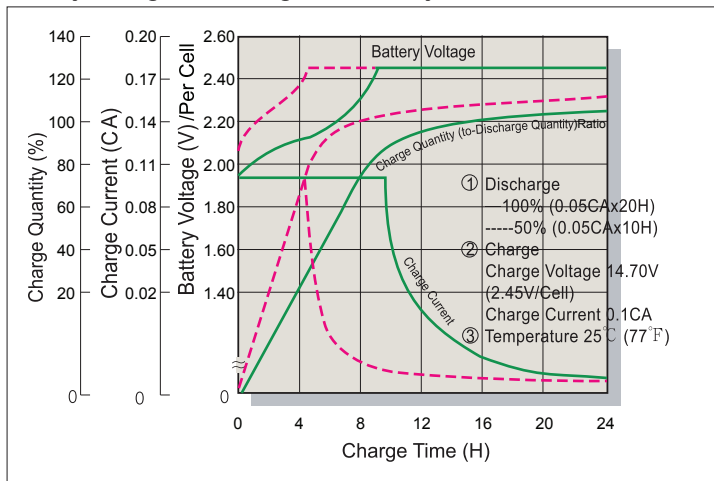

### Terminal Voltage (V) and Discharge Time

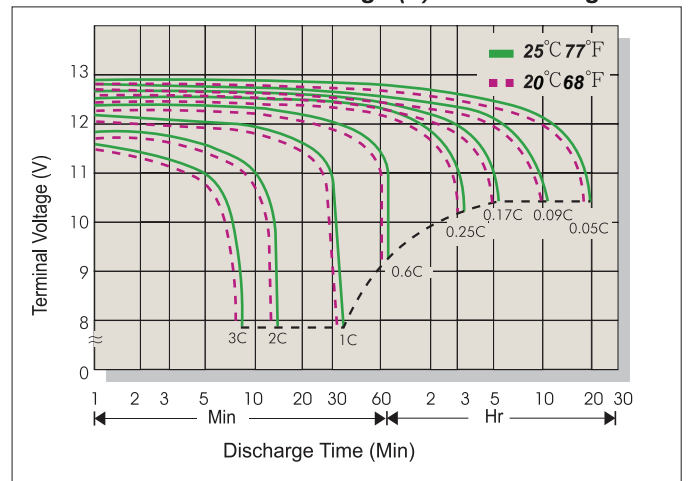

### Charging Procedures

Application	Charge Voltage(V/Cell)			Max.Charge Current
	Temperature	Set Point	Allowable Range	
Cycle Use	25°C (77°F)	2.45	2.40~2.50	0.3C
Standby	25°C (77°F)	2.275	2.25~2.30	

### Discharge Current VS. Discharge Voltage

Final Discharge Voltage V/Cell	1.75	1.70	1.65	1.60
Discharge Current(A)	0.2C>(A)	0.2C<(A)<0.5C	0.5C<(A)<1.0C	(A)>1.0C

### Effect of temperature on capacity (20HR)

Temperature	Dependency of Capacity (20HR)
40 °C	102%
25 °C	100%
0 °C	85%
-15 °C	65%

### Self-discharge Characteristics

Storage time	Preservation rate
3 Months	91%
6 Months	82%
12 Months	64%